

FEATURES

- Flow Direction Detection with Forward/Reverse.
- Optional pulse value per litre on any given size.
- 4 – 35 V DC input voltage range.
- P.D. Nutating (wobbling) disc measuring chamber.
- Small impurities can pass chamber without jamming.
- Low hydraulic thrust minimises wear.
- High pulse output rate for precision flowrate and batching applications.
- Measures Admixtures to 1.4-SG.
Accuracy largely unaffected by varying viscosities & S.G.
- ± 1.5 % flow range accuracy curve.
- ± 0.2 % repeatability or better
- Sizes 20, 25, 32 & 40mm



Conforms to AS3565-1988, designed to meet AS3901.

Approvals : C700-AWWA,SDWA-NSF372

The MES range of nutating disc, magnetically-coupled, positive displacement pulse output flowmeters (introduced in 1995, with most still operational) are suitable for a wide range of precision batching and flowrate monitoring applications, operating from low to high flow ranges.

Unlike rotary piston and oval rotor principle meters, the nutating disc flow chamber can pass small impurities without jamming, whilst maintaining exceptional measurement accuracy with only minimal headlosses. Measurement of concrete admixtures and water-based chemicals with varying specific gravities up to 1.4 is achieved with only insignificant calibration variations (hence not having to change calibration values).

The new Pulsehead with digital smart pulse (DSP) transmitter is a self-contained unit which couples to the meter body with a bayonet lock and turn fitting connection, while being fully isolated from the fluid measuring chamber. Pulse outputs are available as Digital Pulse Output (replaces the Transistor type) or Contact Closure. The pulsehead unit is rated to IP63 protection (when using the outer cover cap).

The latest MES flowmeter Pulsehead model "DSP" (*Digital Smart Pulse*), uses magnetic sensors and a microcontroller unit to process and sample the signals which provides latest technology ultra-stable pulse outputs. In addition, DSP technology is optionally able to determine the direction of the flow, through three separate, live output channel options.

Further, optionally the number of pulses per litre can be ordered for the output pulse as well, to make it suitable for expanded applications.

To make this design completely interchangeable with previous model pulseheads, the default output mode is standard with bi-directional pulse (Pulse output is live regardless of flow direction) and 1000 pulses per litre is standard on a 20mm measuring body. The different pulse value per litre will apply on the larger body sizes as per the table. Alternatively Output pulse value modes can be nominated at the time of purchase.



New MES20-N pictured

MES-P Flowmeters Specifications Table						
Technical Specification		Model Number	MES20	MES25	MES32	MES40
Sizes (mm)			20mm	25mm	32mm	40mm
Digital (Standard)	Output rate (Pulses Per Litre)	Default/Standard: 1000 PPL on 20mm measuring body Available options: 1, 10, 20, 50, 100, 250, 500 & 1000				
	Standard outputs	1000	555	261	116	
	Optional outputs	1 / 10 / 100 / 1000 pulses/litre (any size)				
	Supply voltage / current consumption	+ 4 to 30V DC // 3 – 17mA proportional to input voltage.				
	Maximum switching capacity	+ 30V DC, 500mA				
	Output options	1. Bi-directional pulse: Generates pulse on output regardless of the direction of flow. (Default/Standard) 2. Forward pulse: Generates pulse output as long as the direction of flow matches the arrow on measuring body. 3. Reverse Pulse: Only generates pulse output in case of backflow.				
Transistor (Superseded)	Output rate (Pulses Per Litre)	1000	555	261	116	
	Supply voltage / current consumption	+ 5 – 25V DC / 5 – 25mA proportional to input voltage.				
	Maximum switching capacity	+ 25V DC, 500mA				
Contact closure	Output rate (Pulses Per Litre)	60.6	34	16	7.2	
	Supply voltage / current consumption	No power supply needed. (2 Wire Connection)				
	Maximum switching capacity	+40V, 400mA				
Accuracy (min – max range)		± 1.5% (repeatability ± 0.2% or better of rate)				
Start Flow @ 5% (Litres/Minute)		0.6	1.1	1.5	3.0	
Minimum Flowrate @ ±1.5 (Litres/Minute)		1.5	2.7	3.8	7.5	
Nominal Flowrate (Litres/Minute)		45	65	125	200	
Maximum Flowrate (Litres/Minute & Admix. s.g. 1.4)		54	80	132	268	
Maximum Flowrate (Litres/Minute & Admix. s.g. 1.1)		70	102	168	340	
Maximum Flowrate (Litres/Minute & Admix. s.g. 1.0)		80	112	185	375	
Weight (including connectors)		1.3Kg	2.3Kg	4.7Kg	17Kg	
Connection Type (BSP)		3/4" (Male)	1" (Male)	1 1/4" (Male)	1 1/2" Oval flanged kit,(Female)	
Metric size reference		20mm	25mm	32mm	40mm	
Maximum Working Pressure		1160 kPa (Headloss at nominal flowrate 25 kPa)				
Connection via IP67 PG9 cable gland entry Pulse head model IP63 rated with outer cap.		3 wire screw down terminals (use shielded signal cable)				
Maximum fluid temperature		50 °C				

DIMENSIONS

Meter Size	mm	20 mm	25 mm	32 mm	40 mm
Length of threaded end meter	L	191	229	273	330
Overall Height of meter	H1	150	178	200	252
Height –underface to centreline	H2	35	48	54	65
Overall Width	W	92	111	165	205

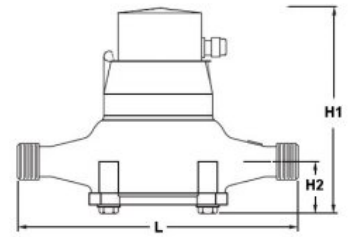
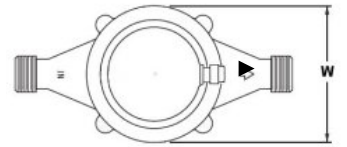

dimensions for 20, 25, 32mm

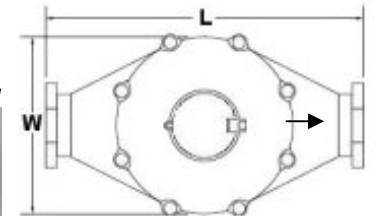
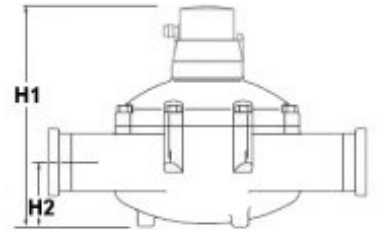

dimensions for 40 mm

PULSE OUTPUT SPECIFICATIONS & CONNECTION

The Pulsehead unit (Digital Pulse/Transistor/Contact Closure) are of the same specification for all sizes. Pulseheads are interchangeable to another body size but be aware pulse value difference. For variable selectable scaling pulse output values, use **UIC/D** Universal Interface Card. For additional 24-240VAC Triac pulse switching, use **UIC/A** interface card.

To connect, remove the moulded housing cover, followed by the housing lid (2 screws). Pass the cable through the gland entry and connect to the terminal connector strip. Screw down on wire, tighten gland and reseal housing and fit cover cap.

To avoid signal interference, use shielded cable only.

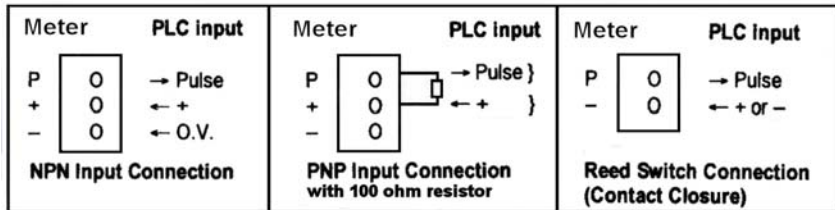

Standard NPN/PNP digital pulse switching 4-30VDC.
The internal transistor will drive up to 500mA
For PNP input fit a 1.5 to 1.8K resistor
 (Value depends on input impedance) **between + and P.**

MES Internal Junction View

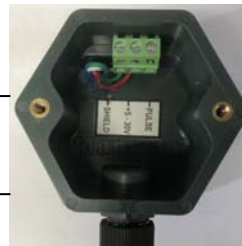

- DSP-OC suitable for ManuFlo devices (no pull up resistor)
- DSP suitable for other input devices (pull resistor fitted inside)

INSTALLATION

1. Install the meter undercover for longevity, the pulsehead is now rated IP63 when hood cap is secured.
2. Consider an accessible area for any future service. Flush out pipes thoroughly before connecting flowmeter in pipework.
3. Flowmeters may be installed in any position without affecting accuracy (but not upside down).
4. **Ensure arrow on meter body coincides with forward flow direction.**
5. Although chamber can pass small impurities, if the fluid contains large impurities, a 1000 micron filter should be fitted prior to meter.
6. Any flow restriction or regulation valve should be fitted preferably before the flowmeter. Quick-closing valves should be fitted before the meter if used for higher-end flowrates (thus avoiding sudden hammer pressures on the flowmeter chamber) provided that the plumbing configuration allows the pipe to remain full where the flowmeter is located.
7. Never exceed the rated maximum flow of the meter, as this could cause damage to the measuring chamber components and/or cause severe overdosing of liquid. Once installed, the flowmeter must measure a full pipe of liquid at all times.
8. Avoid installing the transistor pulse unit in high vibration areas, as this may cause false pulses.
9. **IMPORTANT: AS THE LAST STEP OF INSTALLATION, A CALIBRATION CHECK OF THE FLOWMETER MUST BE PERFORMED.**

MAINTENANCE

If flow becomes excessively restricted, or meter is out of calibration, or output pulses cease, then:

1. Where fitted, push in the pulsehead locking pin; hold pulsehead and turn it anti-clockwise, then pull up and remove pulsehead from the meter body. **CAUTION: Do not press on, or impact, the copper base of the pulsehead.** Use a magnet (or **UMT8** ManuFlo tester) and rotate at the copper base of the pulsehead -this should generate some pulses. (Note: Older transistor/optical pulseheads can be shaken to generate pulses). If not, check voltage supply, connections and cable. If all are OK, then proceed to step 2. If still not working change and upgrade with new DSP (DSP-OC) digital pulsehead.
2. To access measuring chamber (Meter sizes 20, 25 and 32mm) rotate or remove meter body. Remove the base screws, base plate and base sealing ring. Using pliers, pry and pull out the white strainer to free the measuring chamber unit for removal and inspection. For the 40mm size undo the top body plate bolts x8.
3. If required, clean chamber parts in warm water with detergent or diluted acid/water 1:5 ratio. Remove any solids which may be impeding rotation. Be sure internal nutating disc roller pin is in place and that shutter plate is refitted. Blow into the chamber port to see it spins freely. Reassemble meter by reinserting measuring chamber and reposition it with strainer. Re-fit other components and test the meter.
4. If the MES meter runs dry after measuring chemicals, make sure to flush out the meter chamber with water.
5. To avoid moisture ingress to electronics, ensure cable entry gland is secure, cables are looped downwards and the meter is under cover. **IMPORTANT: AFTER ANY SERVICE, MUST PERFORM A CALIBRATION CHECK OF THE FLOWMETER.**

MATERIAL SPECIFICATIONS

- 1. Pulsehead - Polyacetal & ASA-UV.
- 2A. Meter body - Cast gunmetal. AS1565 C83810
- 3. Strainer - Polyolefin.
- 4. (Not used)
- 5. Measuring chamber - Nepton (synthetic polymer), SS316, Polymer barium ferrite magnet.
- 6. Chamber O-ring - NBR rubber.
- 7. Base sealer ring - NBR rubber. (optional 20mm EDPM)
- 8. Base plate - 20mm: Synthetic Polymer.
- 8M. Base plate - 25 & 32mm: Steel powder coated.
- 9. Base body screws - Stainless Steel.
- 14. Top Plate - 40mm: Gunmetal.

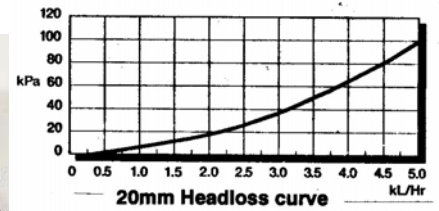
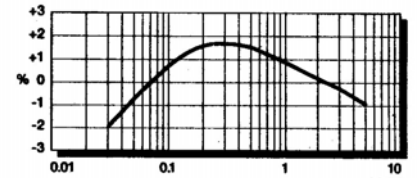

Spares for 40mm size

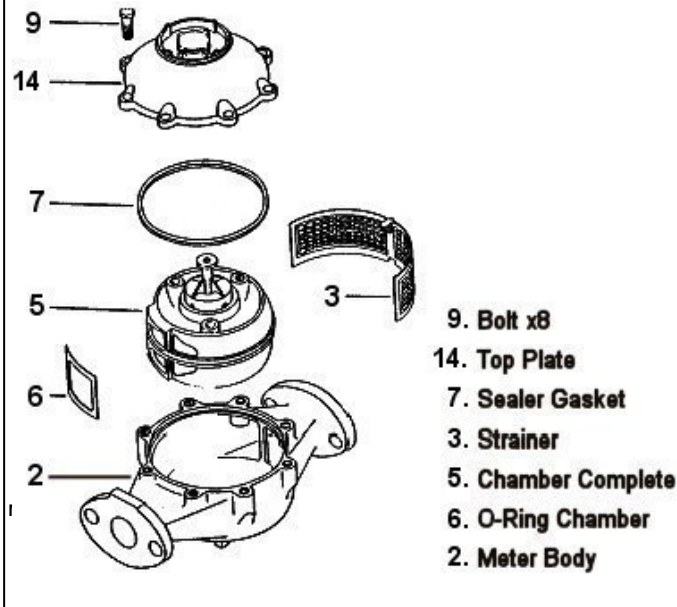

Spares for 20, 25, 32mm Sizes



FLOWMETER ORDER CODES:

Code	Description
MES20-N	20mm Digital pulse OC (1000 pulses/Litre)
Output options:	
-DSP-OC	Standard issue (works with all ManuFlo equipment)
-DSP	Optional issue (with internal pull-up resistor)
Special Optional Pulse output 1/10/100/1000 pulses per Litre	
Options for 20 mm size only:	
MES20R	20mm Contact Closure pulse o/p (60.6 pulses/Litre)
-E	With EDPM base gasket seal (part# -7E)
-T	with Teflon-lined body and couplings for 20mm only

Code	Size	Pulse Type	Pulses / Litre
MES25	25mm	Digital -OC	555
MES25R	25mm	Contact Closure	34
MES32	32mm	Digital -OC	261
MES32R	32mm	Contact Closure	16
MES40	40mm	Digital -OC	116
MES40R	40mm	Contact Closure	7.2

